

300mm

Scotch Tee Hinge





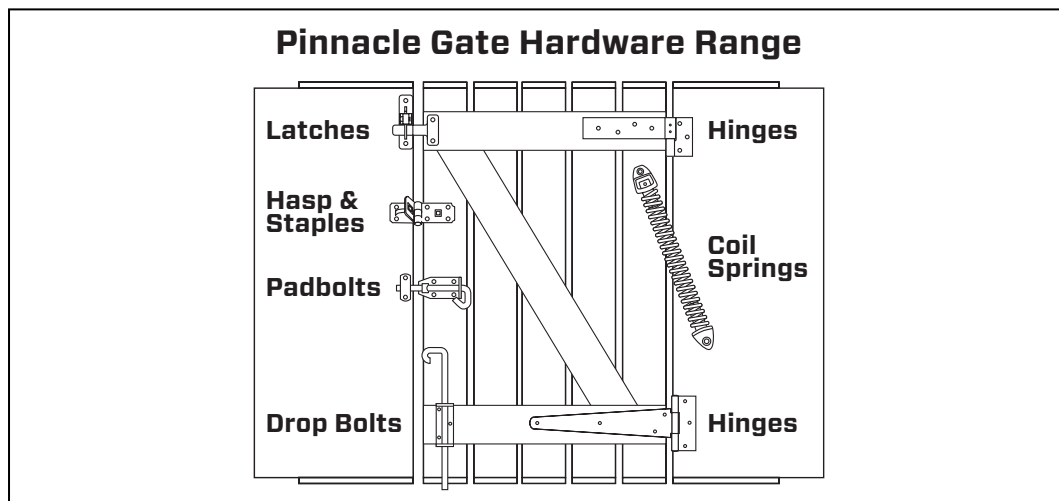
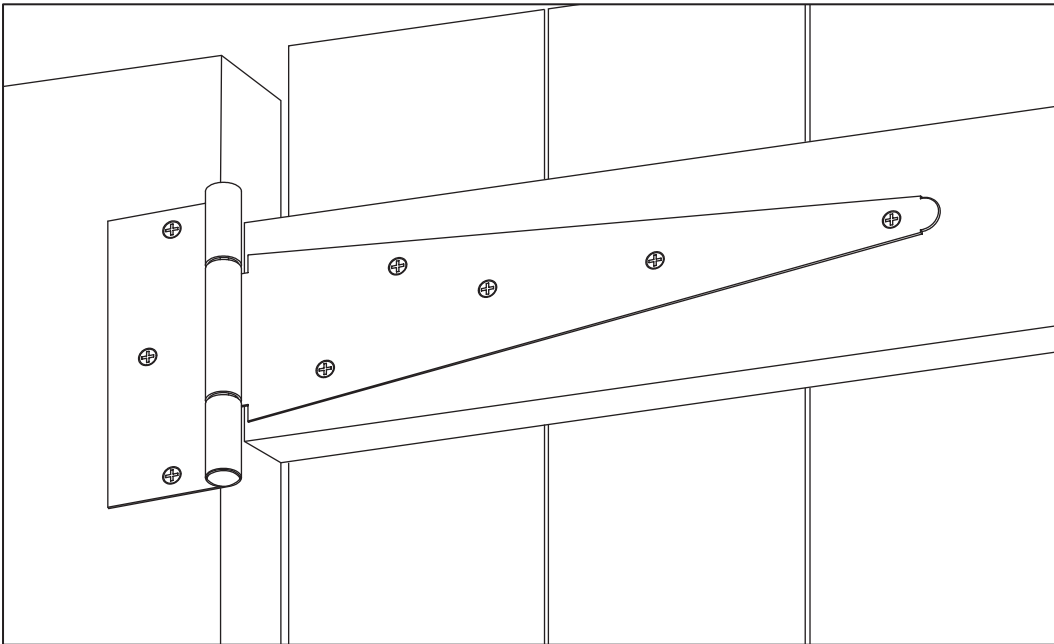

Tools required: Pencil, No.2 Phillips screwdriver, drill and drill bit.

Installation instructions:

1. Place hinge in desired location against the post and gate and mark screw locations.
2. Drill appropriate size pilot holes and fasten with screws.



Corrosion Protection Chart

Finish:	Rating:
Stainless Steel	Ultimate   
Galvanised	High  
Zinc Plated	Moderate 

Suitable for model no: GHS068.